

Montage **i**

Holzjalousie 25 mm

Glasfalzmontage

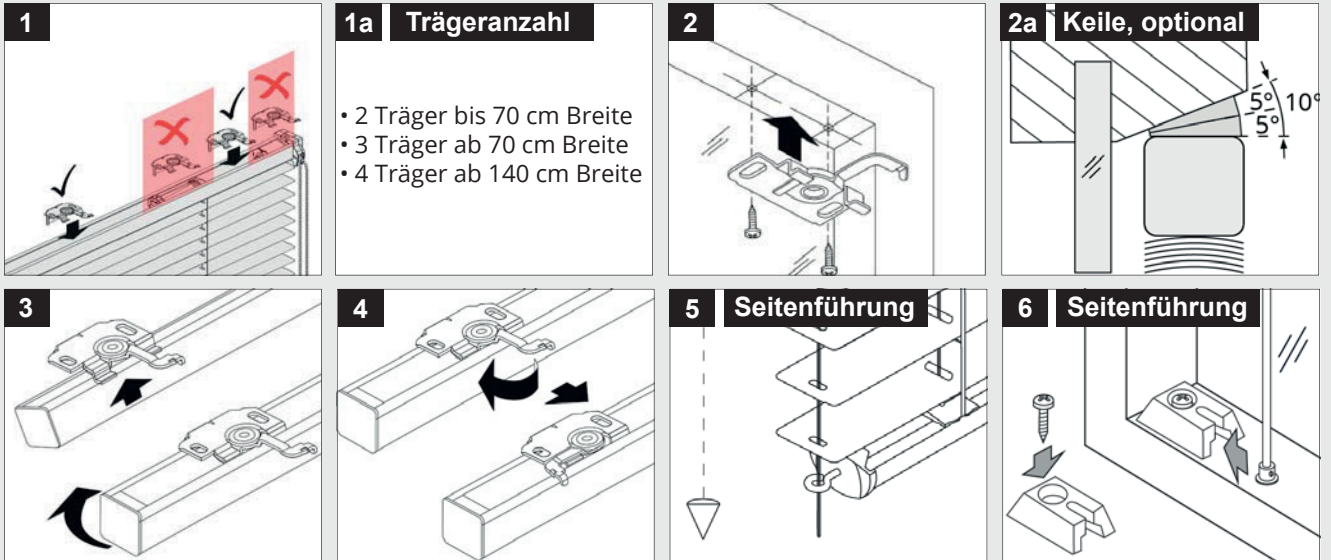

Wand/Fensterflügel

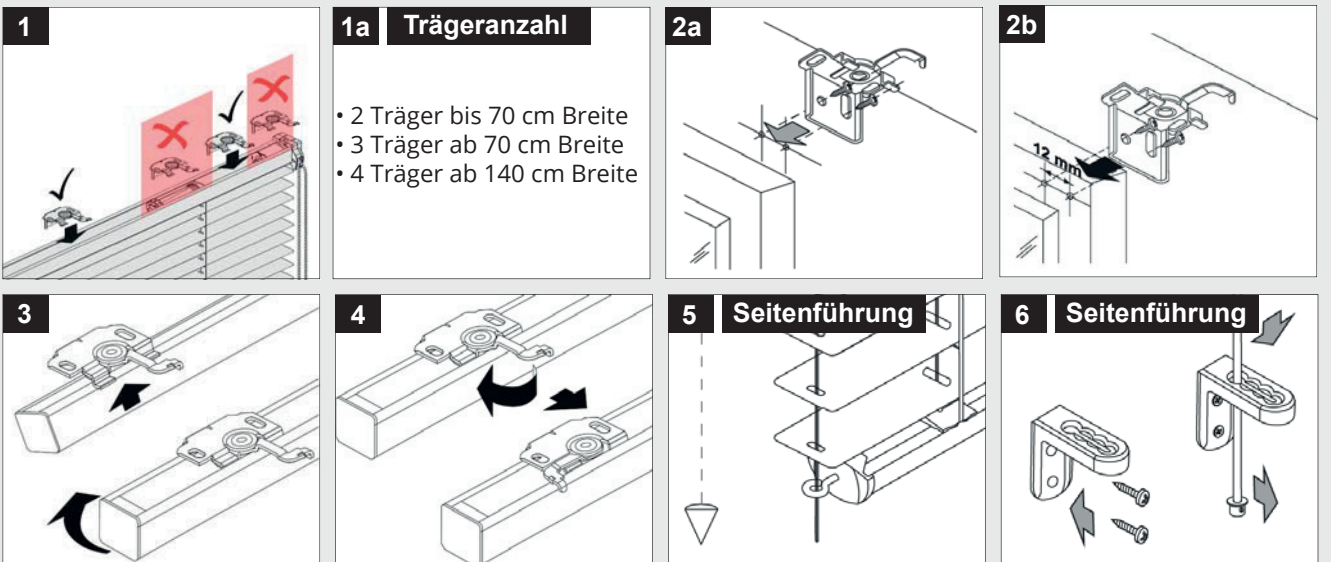

Montage der Abdeckblende

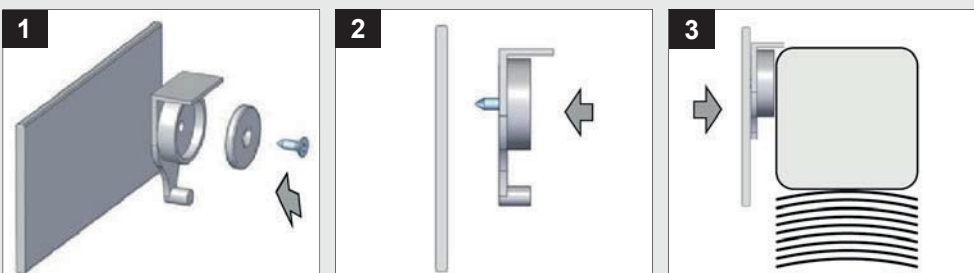

Montage **i**

Holzjalousie 25 mm

Decke - Montage nach oben

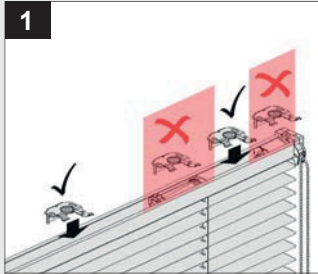

1a Trägeranzahl

- 2 Träger bis 70 cm Breite
- 3 Träger ab 70 cm Breite
- 4 Träger ab 140 cm Breite

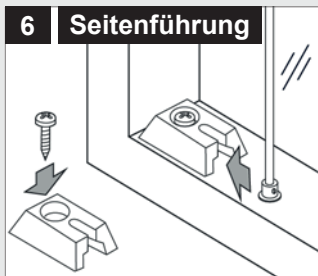
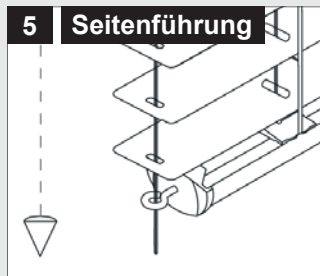
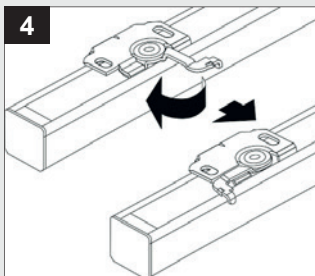
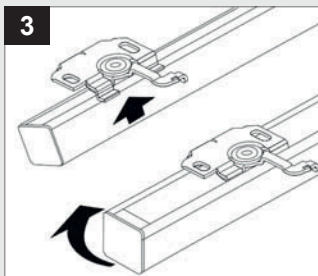
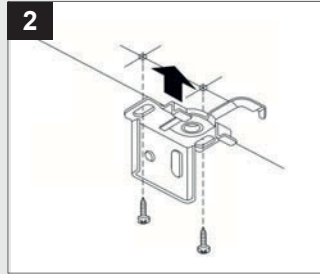

Klemmträger

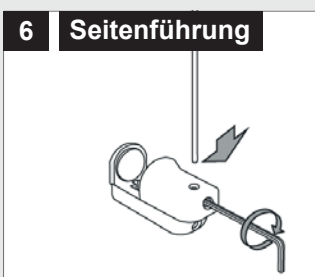
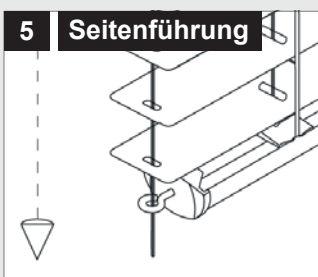
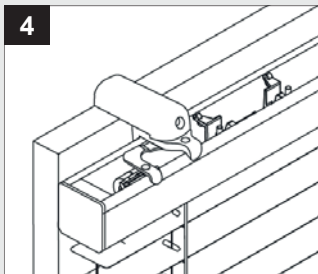
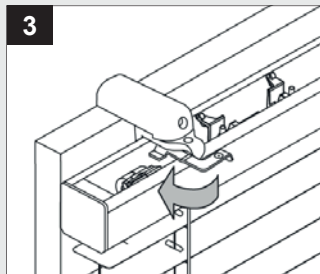
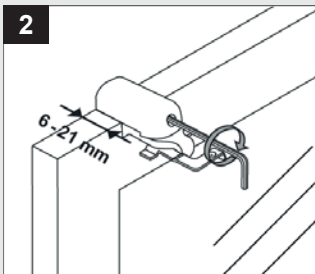
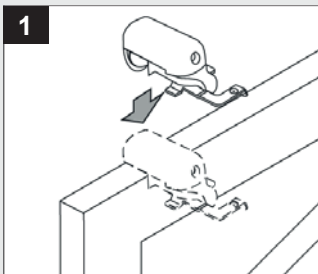

Montage der Abdeckblende

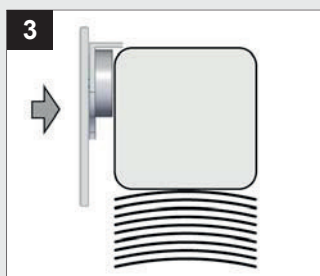
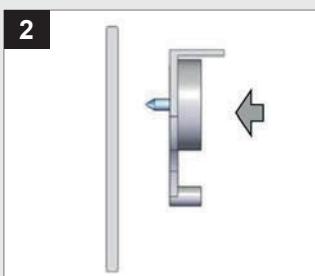
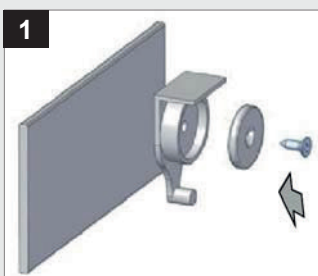

Montage **i**

Holzjalousie 25 mm - Klebemontage

Klebeschienen vorbereiten

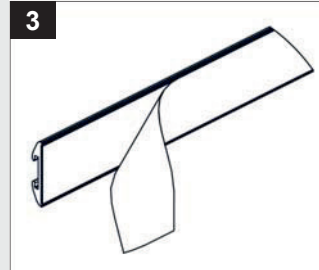
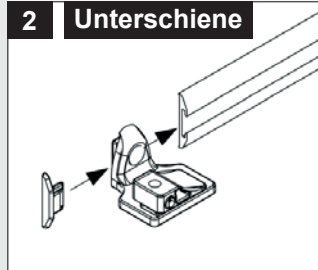
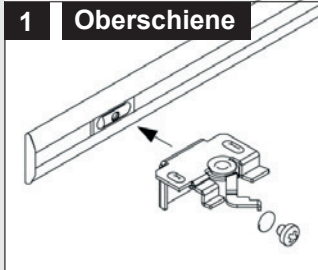

Montage der Klebeschienen am Flügel oder im Glasfalz

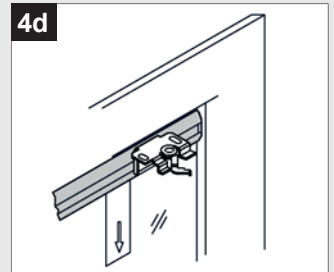
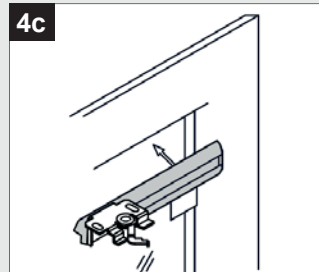
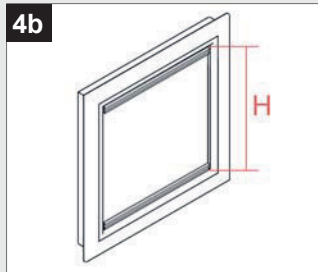
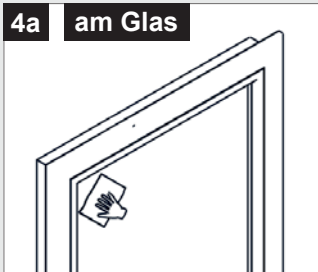
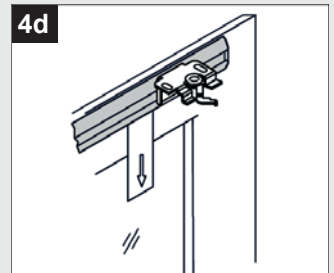
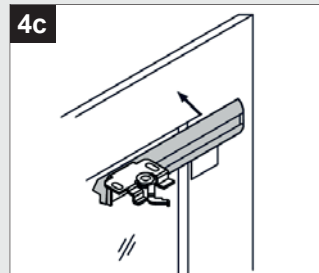
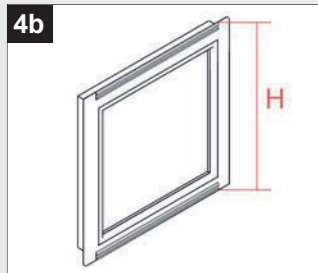
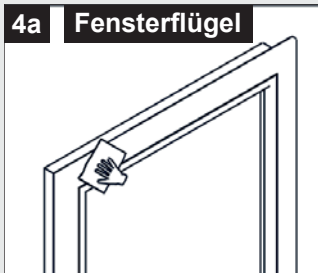

Montage der Jalousie an der Schiene

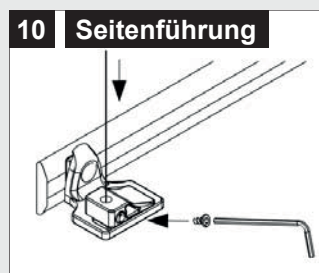
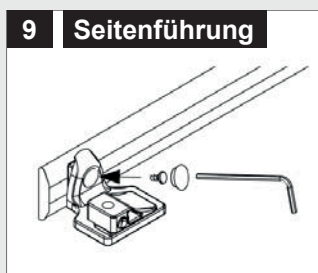
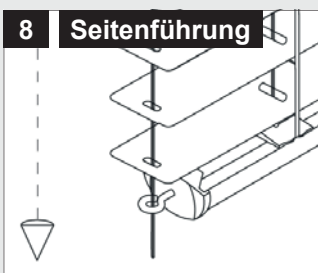
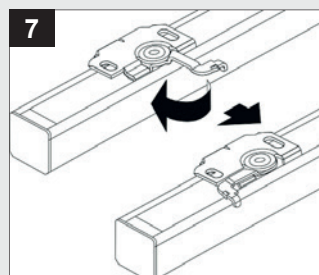
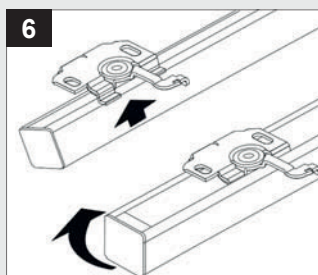

Montage **i**

HolzJalousie 50

Decke/Wand

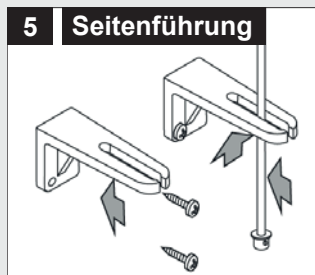
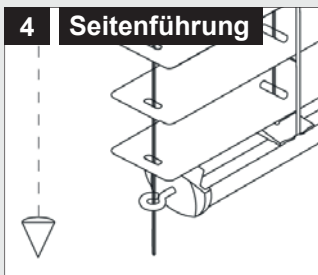
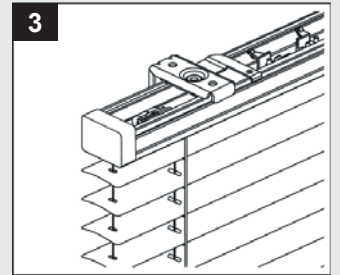
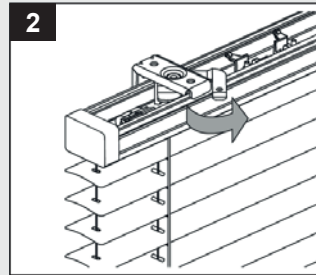
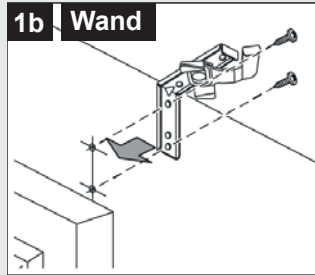
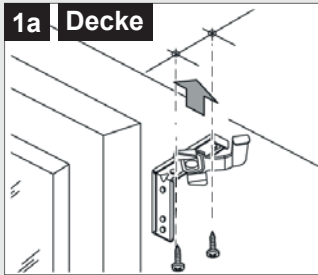

Montage der Abdeckblende

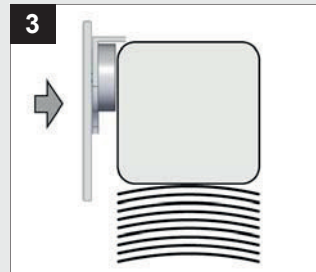
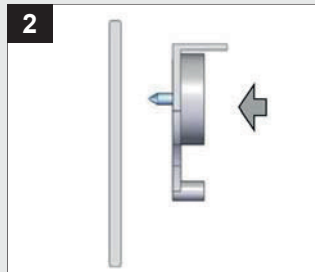
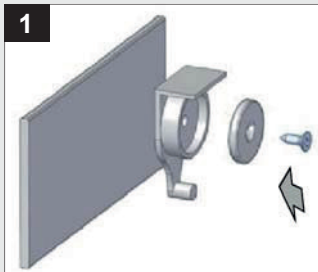

Wir wünschen Ihnen viel Freude mit Ihrer Jalousie!